

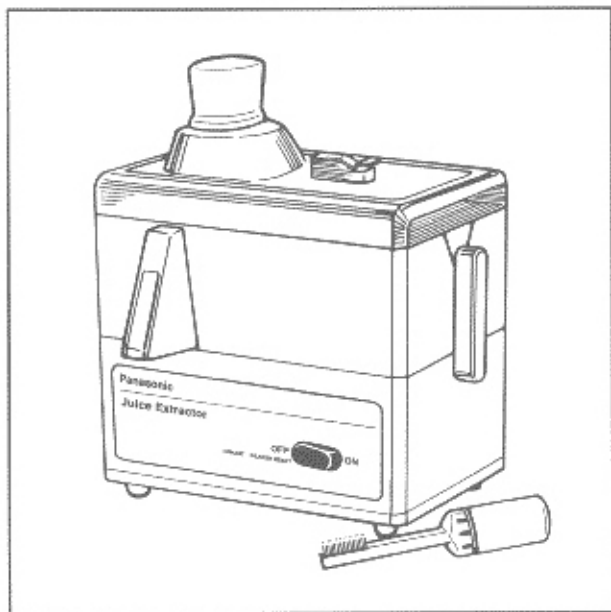

# Operating Instructions

Household Juice Extractor  
**MJ-66PR**



**Panasonic®**

Before operating this unit, please read these instructions completely.

# IMPORTANT SAFEGUARDS

When using electrical appliances, basic safety precautions should always be followed including the following:

1. READ ALL INSTRUCTIONS BEFORE USE.
2. To protect against risk of electrical shock, do not put Motor Housing in water or other liquid.
3. Close supervision is necessary when any appliance is used by or near children.
4. Unplug from outlet when not in use, before putting on or taking off parts and before cleaning.
5. Avoid contacting moving parts.
6. Do not operate any appliance with a damaged cord or plug or after the appliance malfunctions, or is dropped or damaged in any manner. Return appliance to the nearest authorized service facility for examination, repair or electrical or mechanical adjustment.
7. The use of attachments not recommended or sold by the appliance manufacturer may cause fire, electric shock or injury.
8. Do not use outdoors.
9. Do not let cord hang over edge of table or counter, or touch hot surfaces.
10. Do not overload motor with extra heavy loads.
11. Always make sure Container Cover is clamped securely in place before motor is turned on. Do not unfasten Clamps while juice extractor is in operation.
12. Be sure to turn Switch to OFF position after each use of your juice extractor. Make sure the motor stops completely before disassembling.
13. Do not put your fingers or other objects into the juice extractor Feeder Opening while it is in operation. If food becomes lodged in Feeder Opening, use Food Pusher or another piece of fruit or vegetable to push it down. When this method is not possible, turn the motor off and disassemble juice extractor to remove the remaining food.
14. Always place a bowl, glass or cup under the spout.
15. Never wash the parts in hot water or expose them to excessive heat.
16. Do not wash washable parts in a dishwasher.
17. Do not assemble when there is food residue left around the base of the Strainer or Container.
18. All parts must be clean. Food particles left may cause odors, stains or prevent the Strainer from functioning properly.
19. This appliance is intended for home use only and not for commercial or industrial use.
20. Do not place appliance on or near hot gas or electric range.
21. To disconnect, grip plug and pull from wall outlet. Never pull on cord.
22. Make sure Strainer is completely stopped before removing Cover.
23. Never leave room while appliance is running.
24. This appliance should be used only for its intended use as described in the instruction manual.

## SAVE THESE INSTRUCTIONS

**Note:**

- A. A short power-supply cord is provided to reduce the risk resulting from becoming entangled in or tripping over a longer cord.
- B. Extension cords are available and may be used if care is exercised in their use.
- C. If extension cord is used,
  - (1) the marked electrical rating of the extension cord should be at least as great as the electrical rating of the appliance,  
and
  - (2) the longer cord should be arranged so that it will not drape over the countertop or tabletop where it can be pulled on by children or tripped over unintentionally.
- D. This appliance has a polarized plug (one blade is wider than the other). As a safety feature, this plug will fit in a polarized outlet only one way. If the plug does not fit fully in the outlet, reverse the plug. If it still does not fit, contact a qualified electrician. Do not attempt to defeat this safety feature.

# IDENTIFICATION OF PARTS AND DISMANTLING

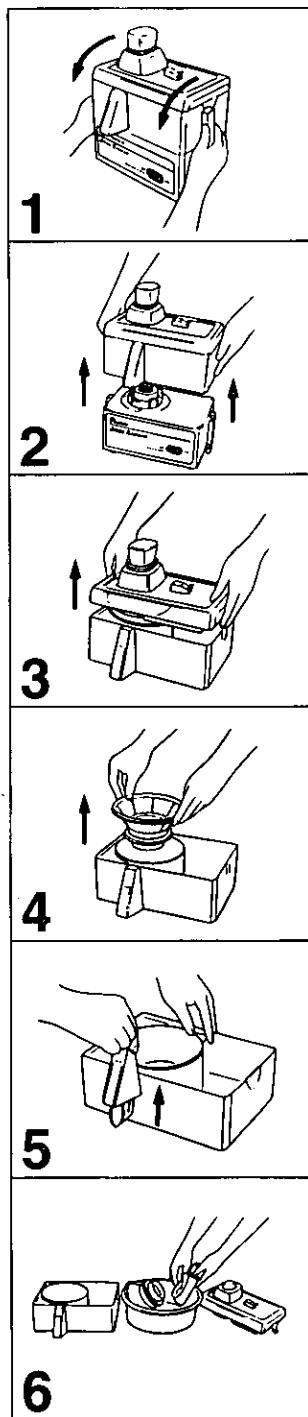
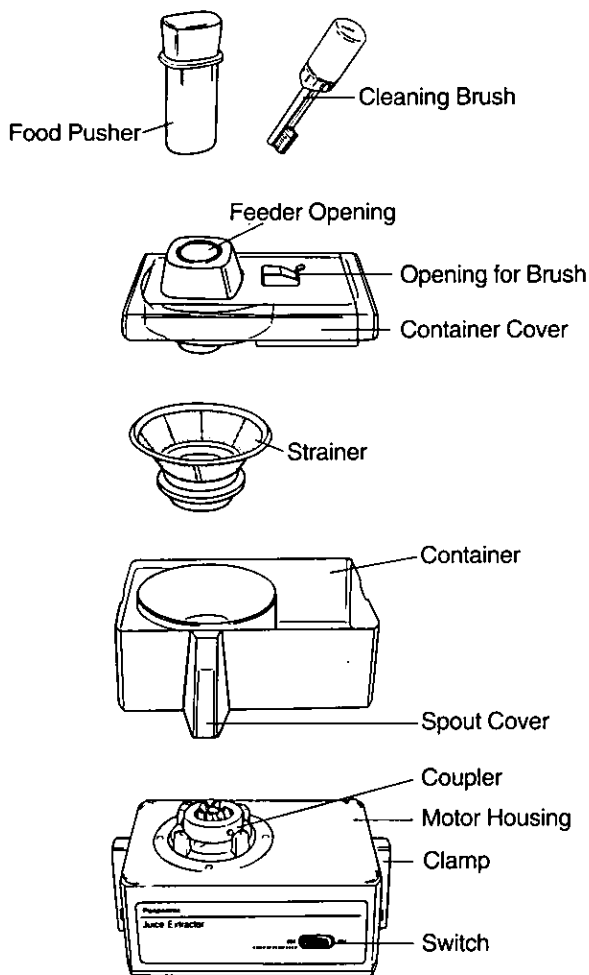

## TO DISMANTLE

1. Release Clamps as arrows indicate.
2. Lightly lift up the Container. The Strainer will come with it.
3. Remove the Container Cover.
4. The Strainer can be easily removed from the Container by lifting it out by the edges.
5. Remove the Spout Cover and clean the spout. Be sure to snap the Spout Cover completely back into place before using.
6. After dismantling each part, wash it in cold or lukewarm water except the Motor Housing.

# HOW TO USE THE JUICE EXTRACTOR

1. Be sure the Clamps are correctly located and locked in position before using the juice extractor.

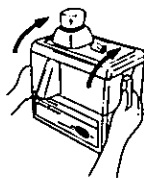

2. Place a glass or bowl under the spout.



3. Preparation of fruit and vegetables:

- Cut large fruit and vegetables into smaller sizes so that they can be easily put into the Feeder Opening.
- Strawberries, bananas, apricots, etc., are not recommended, as juice will not be thin as other fruits.



4. Plug the power cord into a convenient electrical outlet. Your juice extractor is ready for use.

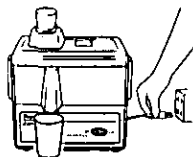

5. Press the Switch "ON". Then put the fruit and vegetables into Feeder Opening by using the Food Pusher.

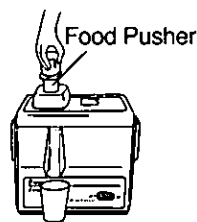

6. After using, the Switch must be turned off and plug should be disconnected.

## CIRCUIT BREAKER PROTECTION

When circuit breaker automatically stops motor due to overloading: after a 10 second interval, switch off. Unplug. Complete the following instructions, then resume operation.

Cut ingredients small enough to fit into feeder opening. Push ingredients into feeder gently; too much force activates circuit breaker.

# HOW TO CLEAN THE STRAINER

1. Fill the Bottle with water and attach the Brush Unit as shown. Do not use any other brush. Do not use the Cleaning Brush when there is no water in the Bottle.
2. Place a glass or bowl under the spout and push the Switch "ON".
3. Make sure that the Strainer is turning, then open the Lid and insert the Cleaning Brush.
4. Move the Cleaning Brush back and forth while squirting water from the Bottle. Be sure to insert the shaft completely before pulling it back. Do not switch the power on and off while the Cleaning Brush is inserted, or the Strainer will be damaged.
5. After removing the Cleaning Brush, push the Switch "OFF". And unplug the unit.
6. Clean the Brush Unit after each use. Take the Strainer out after cleaning and rinse it with clean water.

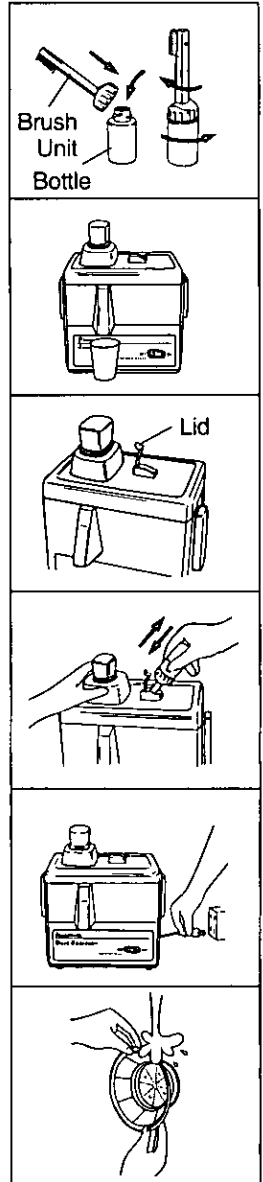

# CARE AND MAINTENANCE

1. Disconnect power plug. Rinse each part in cold or lukewarm water only. Never wash any parts in a dishwasher.
2. After rinsing, wipe off the water and let it dry before storing.
3. To clean the Motor Housing, simply wipe with a damp cloth and dry.

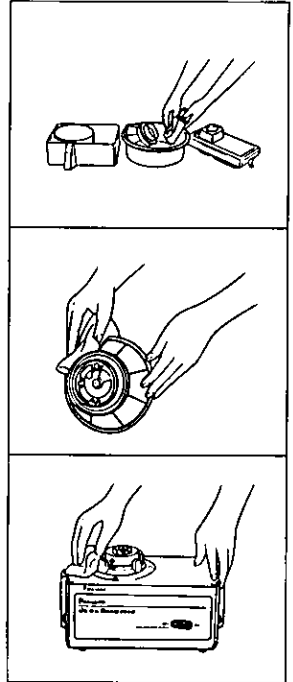

- DO NOT PUT MOTOR HOUSING IN WATER OR OTHER LIQUID.
- NEVER WASH THE PARTS IN HOT WATER OR EXPOSE THEM TO EXCESSIVE HEAT.
- DO NOT CLEAN THE PARTS WITH HARSH CLEANERS OR SOLVENTS.
- DO NOT PLACE THE WASHABLE PARTS IN THE DISHWASHER.

# How to make vegetable juice and good way to drink it.

## **Drink juice fresh.**

Among other elements contained in vegetable juice, vitamin C may be oxidized and damaged when it is exposed to the air. Drink juice fresh.

## **Use available ingredients**

Seasonal vegetables and fruits are more nutritious and better in taste. Outer leaves of cabbage or leaves of celery which, may not be often used for cooking, are also highly nutritious and may be utilized for making juice.

## **Watch for the balance of ingredients**

Mix various ingredients in good balance. Basic mixture is 1-3 vegetables and one fruit.

## **Deterring discoloration**

For the juice which could be quickly discolored such as apple juice, lemon will work effectively to deter the discoloration.

## RECIPES

### **Carrot & Apple Juice**

Ingredients (1 serving)

1/2 medium size apple

1/2 medium size carrot

1/4 lemon

#### Note

Remove the core of apple and peel lemon.

As you get accustomed to this juice, add carrot little by little.



# RECIPES

## **Cabbage & Apple Juice**

Ingredients (1 serving)

3 leaves of cabbage

$\frac{3}{4}$  medium size apple

2 sprigs parsley (medium size)

$\frac{1}{4}$  lemon

### **Note**

Roll parsley in leaves of cabbage before placing in the feeder opening.  
Remove the core of apple and peel lemon.

Sweetness of apple reduces the smell peculiar to vegetables and makes the juice easier to drink.

## **Celery & Tomato Juice**

Ingredients (1 serving)

$\frac{1}{3}$  medium size celery stalk

$\frac{1}{2}$  medium size tomato

3 leaves of lettuce

$\frac{1}{2}$  medium size apple

### **Note**

Remove the core of apple and hull from tomato.  
Feed celery and lettuce first and then apple, in order to ease removal of dreg.

Fully ripe tomato, fresh from the fields is recommended.

## **Celery & Carrot Juice**

Ingredients (1 serving)

$\frac{1}{3}$  medium size celery stalk

$\frac{1}{2}$  medium size carrot

$\frac{3}{4}$  apple

$\frac{1}{4}$  lemon

### **Note**

Remove the core of apple and peel lemon.

Leaves of celery can be used for the juice.

# SPECIFICATIONS

Power supply	120V 60Hz
Power consumed	340 W
Speed	approx. 13,300 rpm
Dimensions (H × W × D)	approx. 12.6 × 11.3 × 9.3 inches
Weight	approx. 6.6 lbs

**Panasonic Consumer Electronics Company**  
**Division of Matsushita Electric Corporation of America**  
One Panasonic Way Secaucus,  
New Jersey 07094